

# NEW LED EMERGENCY LIGHTING UNITS

HIGH-PERFORMANCE ENVIRONMENT  
FRIENDLY TECHNOLOGY

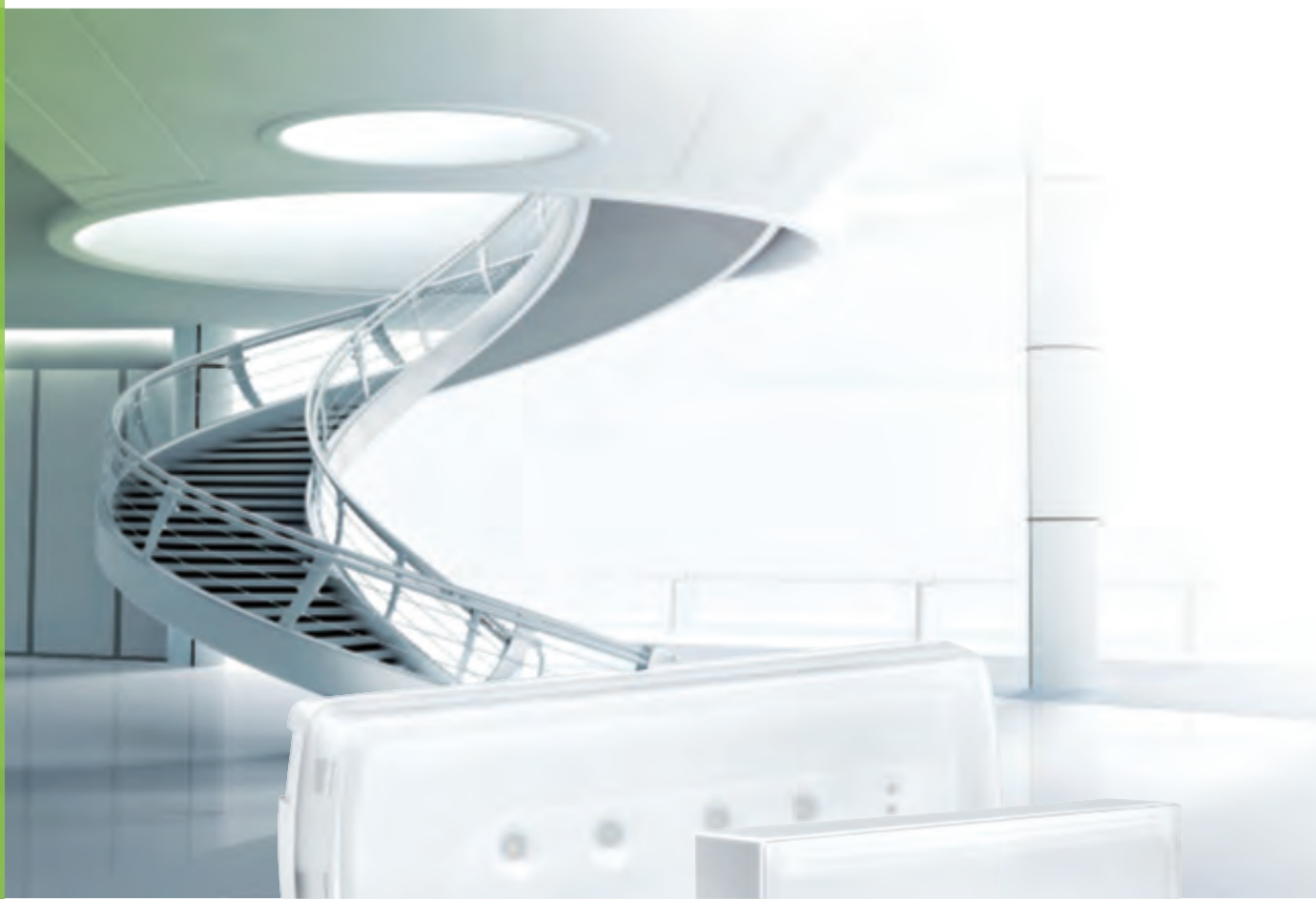

CATALOGUE  
PAGES  
INSIDE

THE GLOBAL SPECIALIST IN ELECTRICAL AND  
DIGITAL BUILDING INFRASTRUCTURES

 **legrand**<sup>®</sup>



# NEW LED EMERGENCY LIGHTING UNITS

HIGH-PERFORMANCE ENVIRONMENT FRIENDLY TECHNOLOGY

- 01 | LEGRAND PRINCIPLES
- 02 | GUARANTEED SECURITY
- 04 | URA ONE
- 06 | U21<sup>LED</sup>
- 08 | B65<sup>LED</sup>
- 10 | CATALOGUE PAGES





# LEGRAND PRINCIPLES

## INNOVATION

LED technology, high-performance products, reducing energy consumption and greenhouse gas emissions. Our commitment is to make available for you innovative solutions ensuring the safety of people.

## STANDARD COMPLIANCE

We manufacture our products by applying the most stringent quality controls, complying with the requirements of standards IEC and EN 60598-2-22.

## ECO-DESIGN

We take account of the environmental dimension throughout the entire life cycle of our emergency lighting units.

## INTEGRATION

Attractive products smoothly integrated into the building  
Discreet products that disappear into the different architectural spaces while remaining visible when needed.





# GUARANTEED SECURITY

Emergency lighting units with automatic testing system reduce maintenance time and costs.



Emergency lighting units are essential products that must be fully operational in order to ensure the safety of people in the event of emergency evacuation. Proper maintenance is the only guarantee of their good working order.

Legrand provides you with 3 control options to suit the needs of your installation.

## 1 STANDARD EMERGENCY LIGHTING UNITS

Maintenance tests have to be performed manually.

## 2 LVS2 AUTOTEST EMERGENCY LIGHTING UNITS

Autotest emergency lighting units automatically carry out a weekly test for emergency mode and lamp status check and a quarterly test for battery duration check.

The test's result is visible on the product through 2 signalling LEDs (green and amber) :

- Green LED (on steady or blinking) : unit operational.
- Amber LED blinking : lamp defective.
- Amber LED on steady : battery defective.

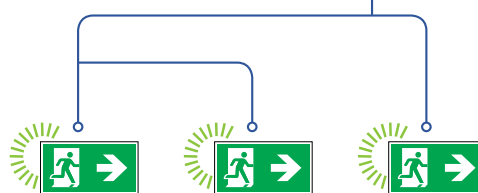

## 3 LVS2 AUTOTEST & ADDRESSABLE EMERGENCY LIGHTING UNITS

The operational status of every emergency lighting unit is continuously checked and centralized in the control interface, and displayed on background plans of the building with the new LVS2 PC supervision software.

All emergency lighting units are interconnected to a dedicated Legrand bus line.



# URA ONE

LED minimalism extra slim  
Compact size



## 1 TECHNICAL SPECIFICATIONS

- Low power consumption.
- Longlife high power LED (>100,000 h).
- Optimized lighting distribution.
- Non maintained and Maintained units.
- Standard and autotest / addressable units.
- Lumen output: 70 to 350 lumens.
- IP42-IK07.
- Duration: 1, 2 and 3 hours.
- Opal diffuser.
- Rest mode with remote control unit (DIN rail mounted).

## 2 INSTALLATION

- Quick and safe installation.
- Translucent plug-in base for easy refurbishment.
- Automatic terminals in the base.
- Toolless snap-fit product mounting.
- Surface-mounting, slim flush-mounting, suspension and flag-mounting, with or without decorative frame, with or without vertical signalling plate.

## 3 STANDARDS

- Design and manufacturing certified to IEC and EN 60598-2-22 standards related to luminaires for emergency lighting.
- RoHS compliant
- PEP declaration (Product Environmental Profile).





# U21 LED

LED functionality  
Energy efficiency



## 1 TECHNICAL SPECIFICATIONS

- Reduced power consumption.
- Longlife high power LED (>100,000 h).
- Non maintained and Maintained units.
- Standard and autotest / addressable units.
- Lumen output: 70 to 350 lumens.
- IP42-IK07.
- Duration: 1, 2 and 3 hours.
- Opal diffuser.
- Rest mode with remote control unit (DIN rail mounted).

## 2 INSTALLATION

- Quick and safe installation.
- Plug-in base.
- Automatic terminals in the base.
- Toolless snap-fit product mounting.
- Surface-mounting and flush-mounting.

## 3 STANDARDS

- Design and manufacturing certified to IEC and EN 60598-2-22 standards related to luminaires for emergency lighting.
- RoHS compliant



# B65 LED

Functionality LED weatherproof  
Extra weatherproof



## 1 TECHNICAL SPECIFICATIONS

- Low power consumption.
- Longlife high power LED (>100,000 h).
- Maintained units.
- Standard and autotest / addressable units.
- Lumen output: 100 to 350 lumens.
- IP65-IK07.
- Duration: 1 and 3 hours.
- Opal diffuser.
- Rest mode with remote control unit (DIN rail mounted).

## 2 INSTALLATION

- Quick and safe installation.
- Plug-in base.
- Automatic terminals in the base.
- Flexible cable entries for rigid tubes up to Ø25 mm.
- Toolless snap-fit product mounting.
- Surface-mounting.

## 3 STANDARDS

- Design and manufacturing certified to IEC and EN 60598-2-22 standards related to luminaires for emergency lighting.
- RoHS compliant
- PEP declaration (Product Environmental Profile).



# Indoor self-contained emergency lighting luminaire LED

## URA ONE

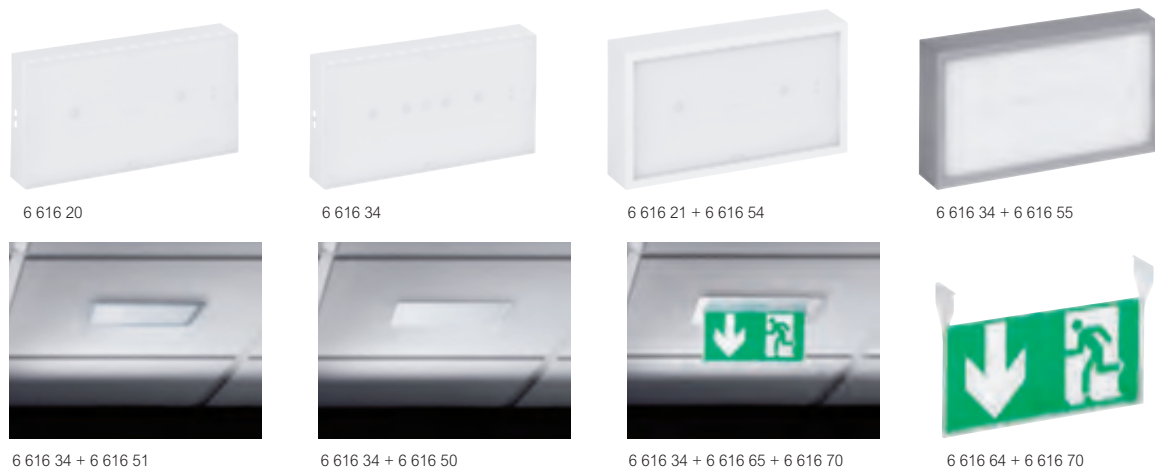

Non maintained and maintained LED emergency lighting units

Certified to IEC and EN 60598-2-22 standards related to luminaires for emergency lighting. High power LEDs with optimized lighting distribution (LED lifetime > 100,000 h). IP 42, IK 07. Power supply: 230 V ± 10% - 50/60 Hz. Class II. Low consumption technology. Switching power supply on maintained units. Duration: 1, 2 and 3 hours. Ni-Cd or Ni-MH batteries. Recharge time: 24 hours. Charge monitor with a green LED

Automatic terminals with high capacity: 2 x 2.5 mm<sup>2</sup> for the electrical power supply and for the remote control circuit. Remote control terminals protected against reversed wiring with the power supply. The remote control may be used to remotely disable the emergency lighting units to avoid unnecessary battery discharge in the event of a deliberate cut in normal lighting. Plug-in back with pre-cut holes grid to ease installation and maintenance. Opal diffuser. Housing fully recyclable. Flat flush-mounting integration into false ceiling & wall with flush-mounting frame Cat.Nos 6 616 50/51. Decorative frame to enhance surface-mounting aesthetic integration Cat.Nos 6 616 54/55

Pack	Cat.Nos	URA ONE Standard emergency lighting luminaires			
		Standard luminaires require manual switching off of normal lighting in order to test emergency lighting			
		<b>Non maintained (NM)</b>			
		Lumens	Duration	Lamps	Battery
1	6 616 20	70	1 h	2 LED	Ni-Cd
1	6 616 21	100	1 h	2 LED	Ni-Cd
1	6 616 22	160	1 h	4 LED	Ni-Cd
		<b>Maintained / Non maintained (M/NM)</b>			
		These Maintained luminaires can also operate in Non maintained mode according to the wiring of regular lighting			
		Lumens	Duration	Lamps	Battery
1	6 616 31	100	1 h	4 LED	Ni-Cd
1	6 616 32	160	1 h	4 LED	Ni-Cd
1	6 616 33	200	1 h	4 LED	Ni-Cd
1	6 616 34	350	1 h	4 LED	Ni-Cd
1	6 616 40	100	3 h	4 LED	Ni-Cd
1	6 616 42	200	2 h	4 LED	Ni-MH

Pack	Cat.Nos	URA ONE Autotest / addressable LVS2 emergency lighting luminaires			
		<b>Maintained / Non maintained (M/NM)</b>			
		Autotest / addressable luminaires incorporate an automatic self-testing system in order to check the emergency mode			
		The test's result is visible on 2 signalling LEDs (green-OK and yellow-defective)			
		Addressable function is activated by setting an ID on each luminaire with infrared configuration tool (Cat.No 0 626 10) and wiring a complementary BUS line.			
		Operating status of all addressable luminaires can be centralized by the control interface (Cat.No 0 626 00) and monitored on a local touch screen controller (Cat.No 0 626 01), or with the building's plan on Legrand Vision System (LVS2) PC software (Cat.No 0 626 02)			
		These Maintained luminaires can also operate in Non maintained mode according to the wiring of normal lighting			
		Lumens	Duration	Lamps	Battery
1	6 626 31	100	1 h	4 LED	Ni-Cd
1	6 626 33	200	1 h	4 LED	Ni-Cd
1	6 626 34	350	1 h	4 LED	Ni-MH
1	6 626 40	100	3 h	4 LED	Ni-MH
1	6 626 42	200	2 h	4 LED	Ni-MH

Pack	Cat. Nos	Accessories
1	6 616 50	Slim flush-mounting frame for false ceiling and dry partition (white colour)
1	6 616 51	Slim flush-mounting frame for false ceiling and dry partition (aluminum colour)
1	6 616 54	Decorative frame for surface-mounting installation (white colour)
1	6 616 55	Decorative frame for surface-mounting installation (aluminum colour)
1	6 616 58	Flag-mounting accessory (white colour) <sup>(1)</sup>
1	6 616 59	Flag-mounting accessory (aluminum colour) <sup>(1)</sup>
1	6 616 62	Suspension mounting accessory (white colour) <sup>(2)</sup>
1	6 616 63	Suspension mounting accessory (aluminum colour) <sup>(2)</sup>
1	6 616 64	Vertical signalling plate for surface-mounting installation (must be completed with adhesive evacuation label)
1	6 616 65	Special flush-mounting frame with vertical signalling plate (must be completed with adhesive evacuation label)

<sup>(1)</sup> Compatible with signalling plate  
Flag-mounted emergency lighting units have a reduced protection index of IP40

Enquire about availability  
<sup>(2)</sup> Compatible with signalling plate, supplied with metal tube Ø16 mm and 40 cm long. Compatible with standard metal tubes Ø16 and 20 mm for higher lengths. Suspension mounted emergency lighting units have a reduced protection index of IP40  
Enquire about availability

## Indoor self-contained emergency lighting luminaire LED - URA ONE



6 616 80



6 616 85



6 616 88

Emb.	Réf.	Adhesive labels for safety signalling
		Dimensions 100 x 200 mm Rotating arrow to 4 directions Pictograms certified to EN ISO 7010 standard
5	6 616 70	Running man pictogram
5	6 616 71	Evacuation pictogram
5	6 616 72	Staircase pictogram
5	6 616 80	Inscription EXIT
5	6 616 81	Inscription UITGANG
5	6 616 82	Inscription SALIDA
5	6 616 83	Inscription SALIDA DE EMERGENCIA
5	6 616 84	Inscription IRTEERA
5	6 616 85	Inscription SORTIDA
5	6 616 86	Inscription SORTIE
5	6 616 87	Inscription SAIDA
5	6 616 88	Inscription NO EXIT
5	6 616 89	Inscription SIN SALIDA
5	6 616 90	Fire extinguisher pictogram
5	6 616 91	Fire hose reels pictogram

## Indoor self-contained emergency lighting luminaire LED - URA ONE

### Installation

Surface-mounting

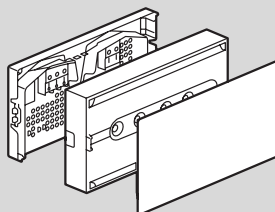

Surface-mounting with vertical signalling plate  
Cat. No 6 616 64

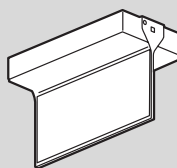

Flush-mounting with the slim flush-mounting frame  
Cat. No 6 616 50/51

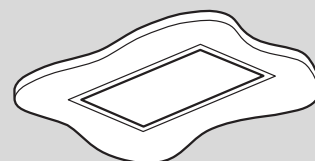

Flush-mounting with a dedicated set including a special flush-mounting frame with a vertical signalling plate  
Cat. No 6 616 65

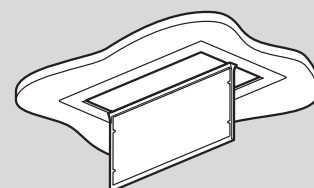

### Dimensions (in mm)

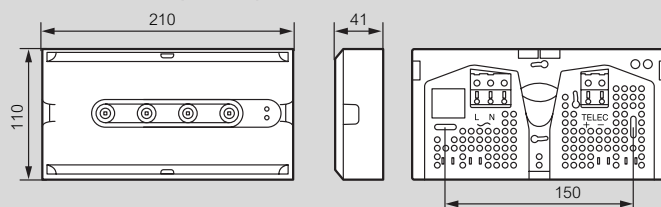

### Accessories

Slim flush-mounting frame Cat. No 6 616 50/51

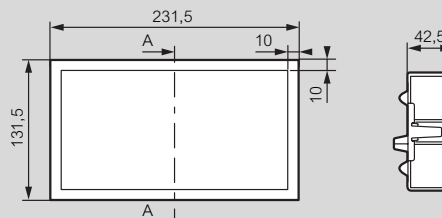

Vertical signalling plate Cat. No 6 616 64

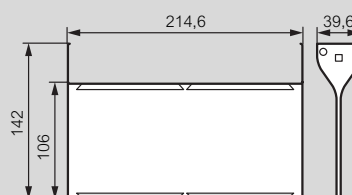

Special flush-mounting with a vertical signalling plate Cat.No 6 616 65

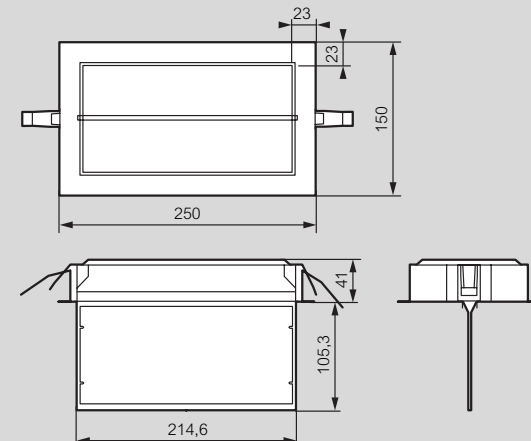

## Indoor self-contained emergency lighting luminaire LED - U21<sup>LED</sup>



6 616 02

6 616 07

Non maintained and maintained LED emergency lighting units  
 Certified to IEC and EN 60598-2-22 standards related to luminaires for emergency lighting. High power LEDs with optimized lighting distribution (LED lifetime > 100,000 h) IP 42, IK 04 - Class II  
 Power supply: 230 V ± 10% - 50/60 Hz. Switching power supply on maintained units. Duration: 1, 2 and 3 hours. Ni-Cd or Ni-MH batteries. Charging time: 24 hours. Charge monitor with a green LED  
 Automatic terminals with high capacity: 2 x 2.5 mm<sup>2</sup> for the electrical power supply and for the remote control circuit  
 Remote control terminals protected against reversed wiring with the power supply. The remote control may be used to remotely disable the emergency lighting units to avoid unnecessary battery discharge in the event of a deliberate cut in normal lighting. Opal diffuser  
 4 cable knock-outs for flexible sheath or rigid tube Ø20 mm : 1 entry in the base ; 2 entries in the sides ; 1 entry on the top  
 Surface-mounting or flush-mounting with frame Cat. No 6 617 20

Pack	Cat. Nos	U21 <sup>LED</sup> Standard emergency lighting luminaires			
		Standard luminaires require manual switching off of normal lighting in order to test emergency lighting			
		<b>Non maintained (NM)</b>			
		Lumens	Duration	Lamps	Battery
10	6 616 01	70	1 h	2 LED	Ni-Cd
10	6 616 02	100	1 h	2 LED	Ni-Cd
10	6 616 05	160	1 h	4 LED	Ni-Cd
		<b>Maintained / Non maintained (M/NM)</b>			
		These Maintained luminaires can also operate in Non maintained mode according to the wiring of normal lighting			
		Lumens	Duration	Lamps	Battery
10	6 616 03	100	1 h	4 LED	Ni-Cd
10	6 616 06	200	1 h	4 LED	Ni-Cd
10	6 616 07	350	1 h	4 LED	Ni-Cd
1	6 616 10	100	3 h	4 LED	Ni-Cd
1	6 616 12	200	2 h	4 LED	Ni-MH

Pack	Cat. Nos	U21 <sup>LED</sup> Autotest / addressable LVS2 emergency lighting luminaires			
		<b>Maintained / Non maintained (M/NM)</b>			
		Autotest / addressable luminaires incorporate an automatic self-testing system in order to check the emergency mode The test's result is visible on 2 signalling LEDs (green-OK and yellow-defective). Addressable function is activated by setting an ID on each luminaire with infrared configuration tool (Cat.No 0 626 10) and wiring a complementary BUS line. Operating status of all addressable luminaires can be centralized by the control interface (Cat.No 0 626 00) and monitored on a local touch screen controller (Cat.No 0 626 01), or with the building's plan on Legrand Vision System (LVS2) PC software (Cat.No 0 626 02). These Maintained luminaires can also operate in Non maintained mode according to the wiring of normal lighting			
		Lumens	Duration	Lamps	Battery
1	6 626 03	100	1 h	4 LED	Ni-Cd
1	6 626 06	200	1 h	4 LED	Ni-Cd
1	6 626 07	350	1 h	4 LED	Ni-MH
1	6 626 10	100	3 h	4 LED	Ni-MH
1	6 626 12	200	2 h	4 LED	Ni-MH

		Accessories			
		<b>Wall flush-mounting</b>			
		With frame and box			
10	6 617 20	Flush-mounting frame for dry partition			
10	0 617 21	Flush-mounting box for masonry			
		<b>Ceiling flush-mounting</b>			
10	6 617 20	Flush-mounting frame for dry partition			

## Indoor self-contained emergency lighting luminaire LED - U21<sup>LED</sup>

### Installation

#### Surface-mounting

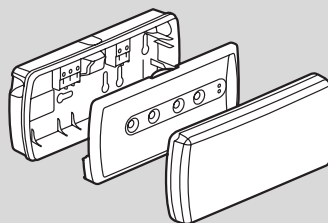

### Dimensions (in mm)

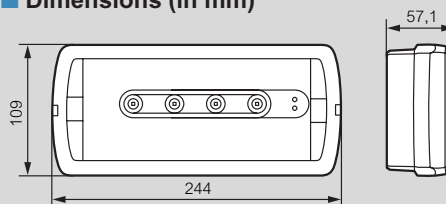

### Accessories

#### Flush-mounting frame

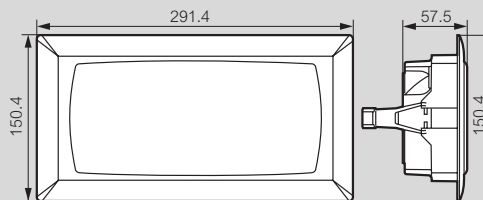

#### Flush-mounting cut-out in dry partitions with Cat. No 6 617 20



#### Flush-mounting cut-out in masonry with Cat. Nos 6 617 20 + 0 617 21

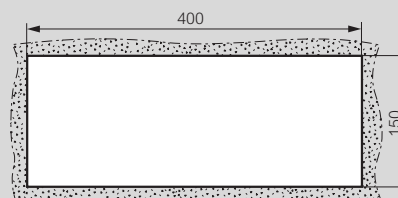



## Weatherproof self-contained emergency lighting luminaire LED - B65<sup>LED</sup>



6 614 33

Maintained LED emergency lighting units which can also operate in Non maintained mode

Certified to IEC and EN 60598-2-22 standards related to luminaires for emergency lighting

High power LEDs with optimized lighting distribution (LED lifetime > 100,000 h)

IP 65, IK 07- Class II

Power supply: 230 V ± 10% - 50/60 Hz.

Low consumption switching power supply

Duration: 1 and 3 hours

Ni-Cd or Ni-MH batteries. Charging time: 24 hours

Charge monitor with a green LED

Automatic terminals with high capacity: 2 x 2.5 mm<sup>2</sup> for the electrical power supply and for the remote control circuit

Remote control terminals protected against reversed wiring with the power supply.

The remote control may be used to remotely disable the emergency lighting units to avoid unnecessary battery discharge in the event of a deliberate cut in normal lighting

Opal diffuser

3 flexible cable entries for rigid tube Ø16, 20 and 25 mm

- 2 entries in the sides

- 1 entry on the top

Surface-mounting

## Weatherproof self-contained emergency lighting luminaire LED - B65<sup>LED</sup>

### ■ Installation

#### Surface-mounting

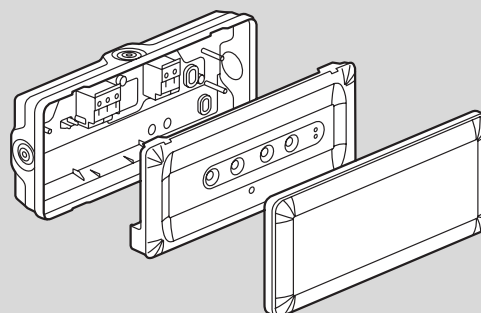

#### Dimensions (in mm)

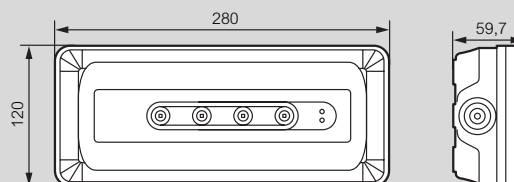

Pack	Cat. Nos	<b>B65<sup>LED</sup> Standard emergency lighting luminaires</b>																				
		<b>Maintained / Non maintained (M/NM)</b>																				
		Standard luminaires require manual switching off of normal lighting in order to test emergency lighting																				
		These Maintained luminaires can also operate in Non maintained mode according to the wiring of normal lighting																				
		<table border="1"> <thead> <tr> <th>Lumens</th> <th>Duration</th> <th>Lamps</th> <th>Battery</th> </tr> </thead> <tbody> <tr> <td>100</td> <td>1 h</td> <td>4 LED</td> <td>Ni-Cd</td> </tr> <tr> <td>200</td> <td>1 h</td> <td>4 LED</td> <td>Ni-Cd</td> </tr> <tr> <td>350</td> <td>1 h</td> <td>4 LED</td> <td>Ni-Cd</td> </tr> <tr> <td>100</td> <td>3 h</td> <td>4 LED</td> <td>Ni-Cd</td> </tr> </tbody> </table>	Lumens	Duration	Lamps	Battery	100	1 h	4 LED	Ni-Cd	200	1 h	4 LED	Ni-Cd	350	1 h	4 LED	Ni-Cd	100	3 h	4 LED	Ni-Cd
Lumens	Duration	Lamps	Battery																			
100	1 h	4 LED	Ni-Cd																			
200	1 h	4 LED	Ni-Cd																			
350	1 h	4 LED	Ni-Cd																			
100	3 h	4 LED	Ni-Cd																			
		<b>B65<sup>LED</sup> Autotest / addressable LVS2 emergency lighting luminaires</b>																				
		<b>Maintained / Non maintained (M/NM)</b>																				
		Autotest / addressable luminaires incorporate an automatic self-testing system in order to check the emergency mode																				
		The test's result is visible on 2 signalling LEDs (green-OK and yellow-defective)																				
		Addressable function is activated by setting an ID on each luminaire with infrared configuration tool (Cat.No 0 626 10) and wiring a complementary BUS line.																				
		Operating status of all addressable luminaires can be centralized by the control interface (Cat.No 0 626 00) and monitored on a local touch screen controller (Cat.No 0 626 01), or with the building's plan on Legrand Vision System (LVS2) PC software (Cat.No 0 626 02)																				
		These Maintained luminaires can also operate in Non maintained mode according to the wiring of normal lighting																				
		<table border="1"> <thead> <tr> <th>Lumens</th> <th>Duration</th> <th>Lamps</th> <th>Battery</th> </tr> </thead> <tbody> <tr> <td>100</td> <td>1 h</td> <td>4 LED</td> <td>Ni-Cd</td> </tr> <tr> <td>200</td> <td>1 h</td> <td>4 LED</td> <td>Ni-Cd</td> </tr> <tr> <td>350</td> <td>1 h</td> <td>4 LED</td> <td>Ni-MH</td> </tr> <tr> <td>100</td> <td>3 h</td> <td>4 LED</td> <td>Ni-MH</td> </tr> </tbody> </table>	Lumens	Duration	Lamps	Battery	100	1 h	4 LED	Ni-Cd	200	1 h	4 LED	Ni-Cd	350	1 h	4 LED	Ni-MH	100	3 h	4 LED	Ni-MH
Lumens	Duration	Lamps	Battery																			
100	1 h	4 LED	Ni-Cd																			
200	1 h	4 LED	Ni-Cd																			
350	1 h	4 LED	Ni-MH																			
100	3 h	4 LED	Ni-MH																			

### Maintained / Non maintained (M/NM)

Standard luminaires require manual switching off of normal lighting in order to test emergency lighting

These Maintained luminaires can also operate in Non maintained mode according to the wiring of normal lighting

Lumens	Duration	Lamps	Battery
100	1 h	4 LED	Ni-Cd
200	1 h	4 LED	Ni-Cd
350	1 h	4 LED	Ni-Cd
100	3 h	4 LED	Ni-Cd

### B65<sup>LED</sup> Autotest / addressable LVS2 emergency lighting luminaires

#### Maintained / Non maintained (M/NM)

Autotest / addressable luminaires incorporate an automatic self-testing system in order to check the emergency mode

The test's result is visible on 2 signalling LEDs (green-OK and yellow-defective)

Addressable function is activated by setting an ID on each luminaire with infrared configuration tool (Cat.No 0 626 10) and wiring a complementary BUS line.

Operating status of all addressable luminaires can be centralized by the control interface

(Cat.No 0 626 00) and monitored on a local touch screen controller (Cat.No 0 626 01), or with the building's plan on Legrand Vision System (LVS2) PC software (Cat.No 0 626 02)

These Maintained luminaires can also operate in Non maintained mode according to the wiring of normal lighting

Lumens	Duration	Lamps	Battery
100	1 h	4 LED	Ni-Cd
200	1 h	4 LED	Ni-Cd
350	1 h	4 LED	Ni-MH
100	3 h	4 LED	Ni-MH



Please check  
these web addresses  
in accordance with  
your country



## FOLLOW US ALSO ON

@ [www.legrand.xx](http://www.legrand.xx)

 [www.youtube.com/legrand](http://www.youtube.com/legrand)

 [www.twitter.com/legrand](http://www.twitter.com/legrand)



### Head office

and International Department  
87045 Limoges Cedex - France

Tel.: + 33 (0) 5 55 06 87 87

Fax: + 33 (0) 5 55 06 74 55